

Maximum Reinforcement and Ductility in Concrete Masonry Shear Walls

Introduction

Concrete masonry shear walls must possess sufficient strength to resist axial, flexural, and shear demands. Additionally, these walls must satisfy specific detailing requirements as outlined in the prevailing codes. These requirements are to ensure that the walls possess adequate ductility in the event of seismic activity. The use of maximum reinforcement ratios is intended to provide ductility by ensuring that the tensile reinforcement yields prior to crushing of the compressive zone.

Examples will be provided to illustrate how to determine the maximum reinforcement permitted in concrete masonry walls in accordance with the 2006 International Building Code (IBC) [1]. For masonry design, the IBC references the ACI 530-05/ASCE 5-05/TMS 402-05 [2], which is also referred to as the 2005 Masonry Standards Joint Committee Building Code (MSJC).

The examples utilized in the Winter 2007 and Fall 2007 issues of "Masonry Chronicles" will be revisited. Results from the previous issues will aid in ensuring the compliance with the governing building codes. Past issues of "Masonry Chronicles" are conveniently located on the Concrete Masonry Association of California and Nevada (CMACN) website (www.CMACN.org).

Nomenclature

The nomenclature used in this article is as follows:

- a = Depth of equivalent rectangular stress block
- A_n = Net area of wall
- A_{sb} = Area of steel in balanced condition
- $A_{s,max}$ = Maximum area of steel allowed
- b = Nominal width of wall
- c = Distance from extreme compression fiber to neutral axis
- C = Compression force
- C_m = Compression force in masonry
- C_s = Compression force in steel
- d = Distance from centroid of tensile reinforcement to extreme compression fiber
- E_m = Modulus of Elasticity of masonry
- E_s = Modulus of Elasticity of steel
- f'_m = Specified compressive strength of masonry
- f_b = Calculated compressive stress in masonry from flexure
- f_s = Calculated tensile stress in reinforcement
- f_y = Specified strength of steel reinforcement
- F_b = Allowable compressive stress due to flexure
- F_s = Allowable tensile or compressive stress in reinforcement
- j_b = Ratio of distance between centroid of flexural compressive forces and centroid of tensile forces at the balanced condition

- k_b = Ratio of depth of compressive stress in flexural member to depth d
- L_w = Length of wall
- M_b = Moment capacity of section at balanced condition
- M, M_E = Moment demand from earthquake
- n = Modular ratio E_s/E_m
- P = Total axial load
- P_D = Dead load axial component
- P_L = Live load axial component
- P_{Lr} = Roof live load axial component
- T, T_s = Tension force
- V, V_E = Lateral earthquake loads
- w_D = Uniformly distributed dead load
- w_L = Uniformly distributed live load
- w_{Lr} = Uniformly distributed roof live load
- α = Tensile reinforcement strain factor
- ϵ_{mu} = Maximum usable strain in masonry
- ϵ_s = Strain in steel reinforcement
- ϵ_y = Yield strain in steel reinforcement
- ρ_b = Reinforcement ratio for balanced condition
- ρ_{max} = Max reinforcement ratio permitted by code

2006 IBC / 2005 MSJC Strength Design Requirements for Maximum Reinforcement

Figure 1 illustrates the relationship between steel tensile strain and the ductility or displacement capacity of a wall. As shown in the figure, walls with larger strains in the tension steel at the ultimate limit state have a greater displacement capacity.

The MSJC code evaluates the ductility of a wall using the tension reinforcement strain factor α . Table 1 summarizes the MSJC strength design requirements for ductility capacity of various members using the tension reinforcement strain factor. Special reinforced and intermediate reinforced masonry walls, which are designed with higher values of R , are more likely to exhibit significant nonlinear response during design level earthquakes. These walls must be able to attain higher values of α at the ultimate limit state. Members designed with lower values of R have less stringent requirements. Members with low aspect ratios, which deflect primarily as a result of shear deformation, are not likely to develop flexural plastic hinges that require significant ductility. Consequently, the code requirements are also less stringent for these members.

Table 1 – Minimum Tension Reinforcement Strain Factor α at Ultimate Limit State for Concrete Masonry Members

Basic Seismic Force Resisting System	R	$\frac{M_u}{V_u d_v}$	α_{min}
Special Reinforced Masonry Shear Walls	5	≥ 1.0	4
		< 1.0	1.5
Intermediate Reinforced Masonry Shear walls	3.5	≥ 1.0	3.0
		< 1.0	1.5
Walls Loaded Out-of-Plane	-	-	1.5
All Others	All	≥ 1.0	1.5
	≥ 1.5	< 1.0	1.5
	< 1.5	< 1.0	None

Figure 2 illustrates the calculations that need to be performed to determine if the reinforcement ratio is acceptable. The neutral axis is selected so that the masonry wall cross-section is in equilibrium with the axial load, which is determined using the load combination $D+0.75L+0.525Q_E$ (MSJC Section 3.3.3.5.1), where Q_E is the effect of the horizontal component of the earthquake load. Note that reinforcement in compression may be used in evaluating equilibrium of the cross-section even if it is not laterally supported by ties (MSJC Section 3.3.3.5.1). Once the location of the neutral axis has been determined, the strain in the extreme tension reinforcement can be obtained and compared to the acceptable value of $\alpha\epsilon_y$. If the maximum tensile strain in the steel is less than $\alpha\epsilon_y$ the wall is over-reinforced and the amount of steel must be reduced or the wall redesigned.

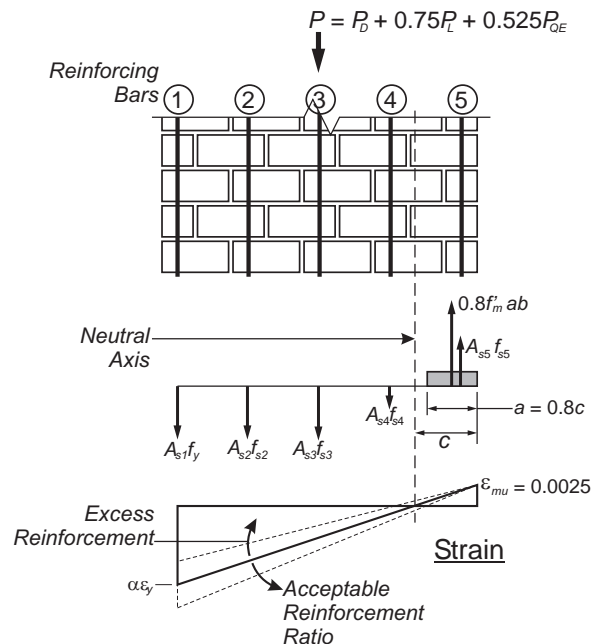

Figure 2 – Maximum Reinforcement in Masonry Shear Walls

To simplify the calculations for maximum reinforcement, the steel reinforcement can be assumed to be evenly distributed as shown in Figure 3.

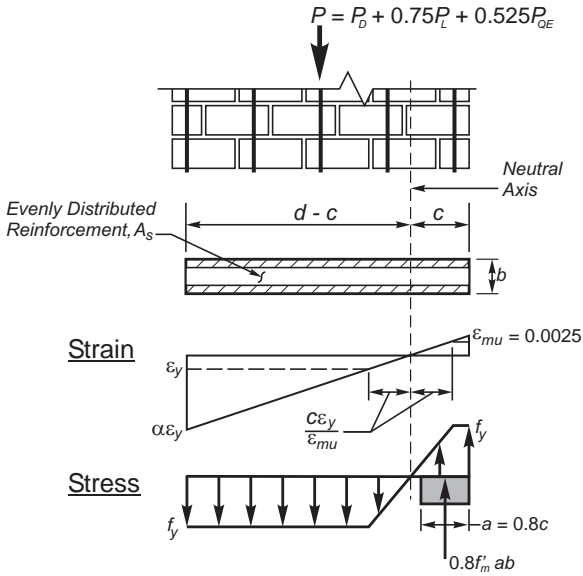

Figure 3 - Determination of Maximum Reinforcement in Masonry Shear Walls

From Figure 3, the compression force in the masonry is:

$$C_m = 0.8(0.8)f'_m bc \quad (1)$$

The tensile force in the reinforcement is given by:

$$T_s = f_y A_{s,max} \left(\frac{L_w - c}{L_w} \right) - \frac{1}{2} f_y A_{s,max} \frac{\epsilon_y c}{L_w \epsilon_{mu}} \quad (2)$$

And the compressive force in the steel reinforcement is equal to:

$$C_s = f_y A_{s,max} \left(\frac{c}{L_w} \right) - \frac{1}{2} f_y A_{s,max} \frac{\epsilon_y c}{L_w \epsilon_{mu}} \quad (3)$$

For equilibrium of forces on the cross-section:

$$C_m + C_s = T_s + P \quad (4)$$

Substituting Equations (1), (2), and (3) into Equation (4) we obtain:

$$A_{s,max} = \frac{0.64 f'_m bc - P}{f_y \left(1 - \frac{2c}{L_w} \right)} \quad (5)$$

From Figure 3, the depth of the neutral axis is given by:

$$c = \frac{\epsilon_{mu} L_w}{\alpha \epsilon_y + \epsilon_{mu}} \quad (6)$$

The maximum permissible amount of reinforcement is given by:

$$A_{s,max} = \frac{0.64 f'_m b \left(\frac{\epsilon_{mu} L_w}{\alpha \epsilon_y + \epsilon_{mu}} \right) - P}{f_y \left(\frac{\alpha \epsilon_y - \epsilon_{mu}}{\alpha \epsilon_y + \epsilon_{mu}} \right)} \quad (7)$$

Therefore, the maximum steel per unit length of wall is equal to:

$$\frac{A_{s,max}}{L_w} = \frac{0.64 f'_m b \left(\frac{\epsilon_{mu}}{\alpha \epsilon_y + \epsilon_{mu}} \right) - \frac{P}{L_w}}{f_y \left(\frac{\alpha \epsilon_y - \epsilon_{mu}}{\alpha \epsilon_y + \epsilon_{mu}} \right)} \quad (8)$$

In terms of the reinforcement ratio on the gross cross section:

$$\rho_{max} = \frac{A_{s,max}}{b L_w} = \frac{0.64 \left(\frac{\epsilon_{mu}}{\alpha \epsilon_y + \epsilon_{mu}} \right) - \frac{P}{L_w b f'_m}}{\frac{f_y}{f'_m} \left(\frac{\alpha \epsilon_y - \epsilon_{mu}}{\alpha \epsilon_y + \epsilon_{mu}} \right)} \quad (9)$$

Figure 4 shows the maximum reinforcement ratio for special reinforced masonry shear walls with various masonry compressive strengths. The figures illustrate the effect of axial load on ductility, and compares the maximum reinforcement ratio to the minimum reinforcement required in Seismic Design Category D and above. It is shown that the ductility requirements result in limits on the axial load that can be placed on a wall. Figure 5 shows the maximum reinforcement ratios for intermediate reinforced shear walls.

Note that Equations (7), (8), (9) and Figures 5 and 6 are only valid for shear walls with relatively closely spaced vertical reinforcement that is evenly distributed along the length of the wall. However, they do provide a tool for obtaining a quick estimate of the maximum reinforcement permitted in all walls.

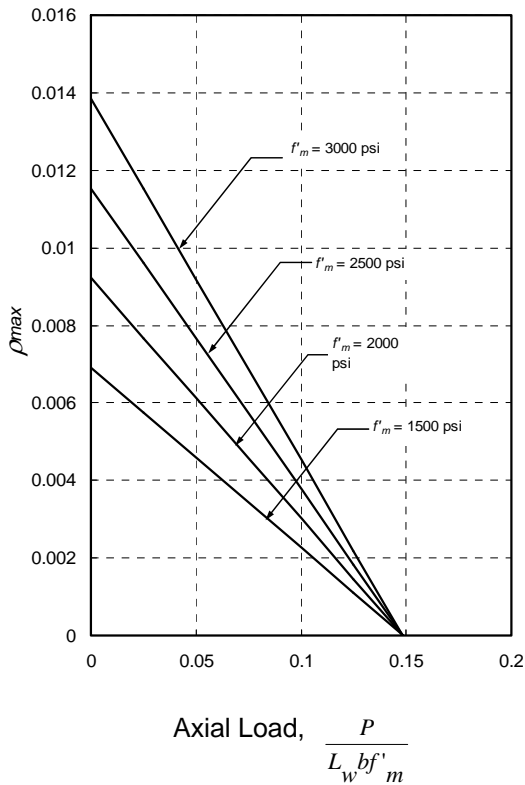

Figure 4 – Maximum Reinforcement Ratio in Special Reinforced Masonry Shear Walls ($f_y = 60$ ksi)

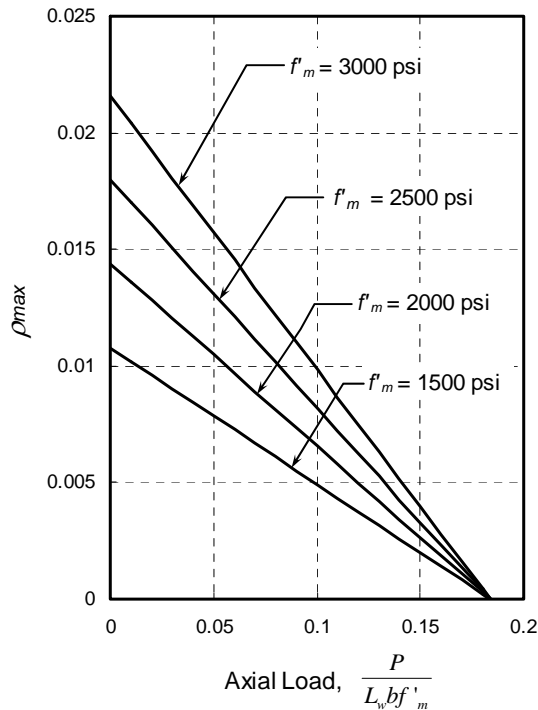

Figure 5 – Maximum Reinforcement Ratio in Intermediate Reinforced Masonry Shear Walls ($f_y = 60$ ksi)

Example 1 – Maximum Reinforcement Ratio of Concrete Masonry Shear Wall Using 2006 IBC Strength Design Procedures

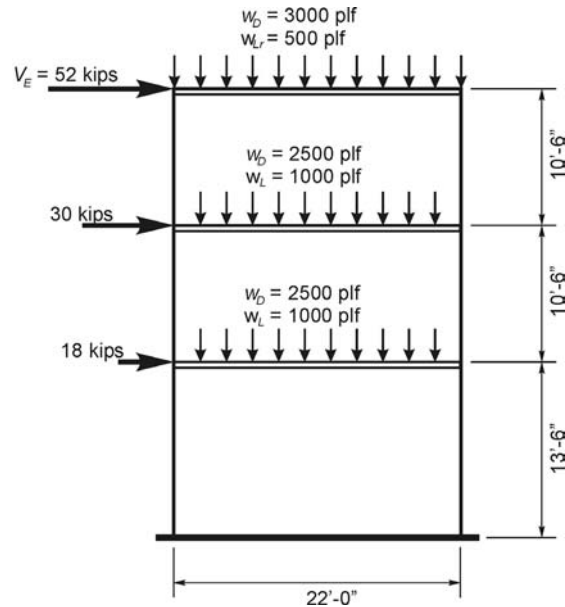

Figure 6 – Multi-Story Concrete Masonry Wall

Determine if the wall shown in Figure 6 satisfies the requirements of the maximum reinforcement ratio according to the 2006 IBC provisions for strength design. The fully grouted wall is constructed with 8-inch, medium-weight concrete masonry units (78 psf). The specified masonry compressive strength is 1500 psi and grade 60 steel is used. The vertical steel in the special reinforced masonry wall consists of #4 bars at 32 inches on center.

Solution:

The in-plane earthquake loads from the first floor are equal to:

$$V_E = 52 + 30 + 18 = 100 \text{ kips}$$

$$M_E = 52(34.5) + 30(24) + 18(13.5) = 2757 \text{ kip-ft}$$

Gravity loads at the first floor are equal to:

$$P_D = \frac{22(3000 + 2500 + 2500)}{1000} + \frac{78(22)(34.5)}{1000}$$

$$= 235 \text{ kips}$$

$$P_L = \frac{22(1000 + 1000)}{1000} = 44 \text{ kips}$$

$$P_{Lr} = \frac{22(500)}{1000} = 11 \text{ kips}$$

According to MSJC Section 3.3.3.5.1d the maximum reinforcement must be checked using the axial load P , from the load combination $D+0.75L+0.525Q_E$:

$$\begin{aligned} P &= D + 0.75L + 0.525Q_E \\ &= 235 + 0.75(44 + 11) + 0.525(100) \\ &= 328.75 \text{ kips} \end{aligned}$$

For a special reinforced masonry wall, the tensile strain factor, $\alpha = 4$. Therefore using Equation (9):

$$\begin{aligned} \rho_{\max} &= \frac{0.64 \left(\frac{0.0025}{4(0.00207) + 0.0025} \right) - \frac{328.75}{(22 \times 12)(1.5)(7.63)}}{\frac{60 \left(\frac{4(0.00207) - 0.0025}{1.5 \left(\frac{4(0.00207) + 0.0025}{1.5} \right)} \right)}{1.5 \left(\frac{4(0.00207) + 0.0025}{1.5} \right)}} \\ &= 0.0018 \end{aligned}$$

The use of #4 bars at 32 inches on center results in a reinforcing ratio of 0.00082. Since there is less steel in the wall than the maximum permitted, the code provision regarding the maximum reinforcing ratio is satisfied.

2006 IBC / 2005 MSJC Allowable Stress Design Requirements for Maximum Reinforcement

The MSJC provisions do not provide ductility-based limitations on the amount of reinforcement that can be placed in a wall. However, Section 2107.8 of the 2006 IBC limits the amount of flexural reinforcement in special reinforced masonry walls with a shear span ratio (M/Vd) equal to greater than 1.0 and an axial load greater than $0.5f'_m A_n$ to the following:

$$\rho_{\max} = \frac{nf'_m}{2f_y \left(n + \frac{f_y}{f'_m} \right)} \quad (10)$$

The maximum reinforcement ratio in Equation (10) does not apply to the out-of-plane design of shear walls.

Equation 1 is derived from the balanced stress condition. The section is considered to be balanced when the allowable masonry stress and allowable steel stress occur simultaneously.

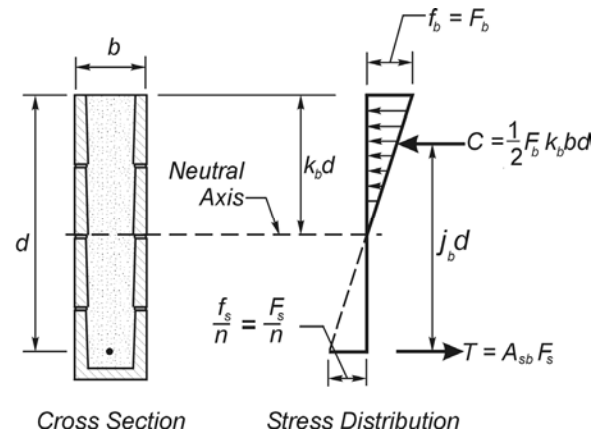

Figure 7 – The Balanced Condition

Figure 7 shows a cross-section at the balanced condition. By similar triangles, the neutral axis is determined to be:

$$k_b = \frac{1}{1 + \frac{F_s/n}{F_b}} \quad (11)$$

The moment arm at the balanced condition will be:

$$j_b = 1 - \frac{k_b}{3} \quad (12)$$

The moment on the cross section is:

$$M_b = \frac{1}{2} F_b j_b k_b b d^2 \quad (13)$$

Solving for d , the effective depth of a cross section subjected to a given moment is:

$$d = \sqrt{\frac{2M_b}{F_b j_b k_b b}} \quad (14)$$

To maintain equilibrium in the cross section, the compressive forces in the masonry must be equal to the tensile force in the reinforcing steel:

$$C = T \quad (15)$$

$$\frac{1}{2} F_b k_b b d = F_s A_{sb} \quad (16)$$

Therefore, the reinforcement required to achieve the balanced condition is equal to:

$$A_{sb} = \frac{F_b k_b b d}{2F_s} \quad (17)$$

or

$$\rho_b = \frac{A_{sb}}{bd} = \frac{k_b F_b}{2F_s} \quad (18)$$

When we substitute the neutral axis depth, k_b , from Equation (11) we obtain the following:

$$\rho_b = \frac{n}{2 \frac{F_s}{F_b} \left(n + \frac{F_s}{F_b} \right)} \quad (19)$$

Substituting f'_m and f_y for F_b and F_s yields the maximum allowed reinforcement ratio as prescribed by the IBC (Section 2107.8):

$$\rho_{\max} = \frac{nf'_m}{2f_y \left(n + \frac{f_y}{f'_m} \right)}$$

The above equation has severe limitations. It is derived for singly reinforced cross-sections and is therefore not completely appropriate for most shear walls, which have reinforcement distributed along the wall length. More importantly, the equation does not include the significant effect of axial load on the allowable maximum reinforcement, as shown in Figures 4 and 5. Figure 8 compares the strength design requirements with Equation (10) for walls with Grade 60 reinforcement. The figure shows that for masonry with a compressive strength of 1500 psi, the allowable stress design equation used in the IBC is non-conservative. For higher masonry compressive strengths Equation (10) is non-conservative for a wider range of axial loads.

To provide a more reasonable comparison with the strength design requirements, the following equation may be utilized for walls with Grade 60 steel:

$$\rho_{\max} = 5 \times 10^{-6} f'_m \left(1 - \frac{P}{0.15 f'_m bd} \right) \quad (20)$$

Figure 9 provides a comparison of the suggested equation for masonry with a compressive strength of 1500 psi and 2500 psi.

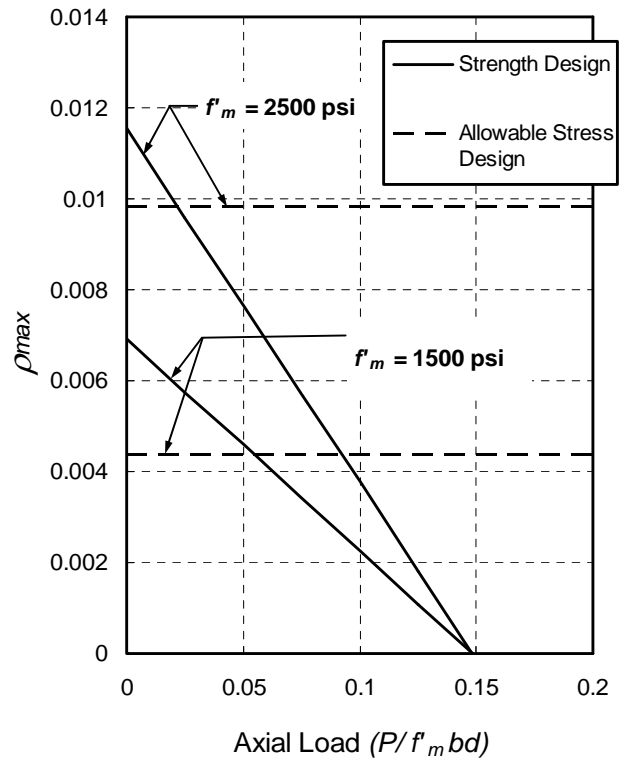

Figure 8 – Comparison of Allowable Stress and Strength Design requirements for Maximum Reinforcement Using Code Equation for Allowable Stress Design

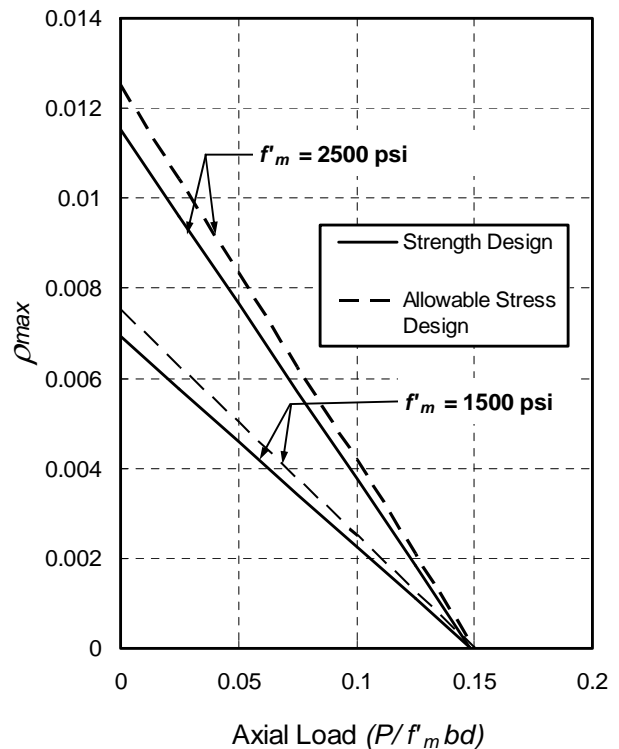

Figure 9 – Comparison of Allowable Stress Design Requirements for Maximum Reinforcement Using Suggested Equation

Conclusion

Maximum reinforcement ratios and detailing requirements in the code seek to improve ductility by limiting the amount of steel used in masonry structures. The limited amount of steel ensures that the steel yields before the concrete masonry has a chance to fail in compression.

The 2006 IBC and 2005 MSJC strength design requirements provide limits on the amount of reinforcement in walls based on the maximum tensile strain in the reinforcing steel. Since the steel tensile strain at the ultimate limit state is directly related to displacement capacity, the strength design requirements provide a reasonable approach in determining the maximum amount of steel permitted.

While the MSJC requirements do not provide ductility-based limits on the amount of reinforcement that can be placed in shear walls under allowable stress design, the 2006 IBC includes an equation that is based on the balanced condition. The equation is generally non-conservative for shear walls, especially at higher axial loads. An alternative equation that compares favorably with the strength design requirements is suggested for use with allowable stress design.

For more information on the design of shear walls please see the 2006 edition of the "Design of Reinforced Masonry Structures". This publication is published and made available through the Concrete Masonry Association of California and Nevada (CMACN).

References

[1] International Code Council (ICC), 2006 International Building Code, International Code Council, Inc., Falls Church, Virginia, 2006

[2] Masonry Standards Joint Committee (MSJC), Building Code Requirements for Masonry Structures, Masonry Standards Joint Committee, Boulder, Colorado, 2005

This edition of Masonry Chronicles was written by Chukwuma Ekwueme, PhD, S.E. and Henry Huang, P.E. and of Weidlinger Associates, Inc., Marina Del Rey, California.

2006 Design of Reinforced Masonry Structures 5th Edition

This book is based on the 2005 edition of the "Building Code Requirements for Masonry Structures" (ACI 530-05/ASCE 5-05/TMS 4-05) as reported by the Masonry Standards Joint Committee (MSJC) and the 2006 International Building Code. Calculations for design loads are referenced to ASCE 7-05. The new edition is co-authored by Gregg E. Brandow, Chukwuma Ekwueme, and Gary C. Hart, and has been significantly updated to be an even more useful text for use in a formal classroom setting, or as a reference for practicing engineers. New figures, tables and text have been included and several examples are solved using both allowable stress and strength design procedures. *(CMA020 - \$80.00)

CMD06 Computer Program

CMD06; is a computer aided design package for the design of Reinforced Concrete and Clay Masonry Elements. CMD06 is a follow up to the very popular CMD97. CMD06 is written by practicing engineers for practicing engineers. CMD06 is a set of modules for the structural design of reinforced concrete and clay masonry elements.

Reinforced concrete and clay masonry elements can be designed utilizing the Strength Design Method found in seven different building codes, including:

- 1997 Uniform Building Code (UBC),
- 2001 California Building Code (CBC),
- 2002 ACI 530/ASCE 5/TMS 402 (MSJC),
- 2003 International Building Code (IBC),
- 2005 MSJC,
- 2006 IBC,
- 2007 CBC

Or, the Working Stress Design Method found in eight different building codes, including:

- 1997 Uniform Building Code (UBC),
- 1999 ACI 530/ASCE 5/TMS 402 (MSJC)
- 2001 California Building Code (CBC),
- 2002 MSJC,
- 2003 International Building Code (IBC),
- 2005 MSJC,
- 2006 IBC,
- 2007 CBC

There are six modules based on the Strength Design provisions for masonry, and four modules based on the Working Stress Design provisions for masonry. The modules operate using a simple menu structure, which allows for the ease of entering data and reviewing and printing the output. The programs also contain various 'flags' which warn the user when certain code provisions are not being satisfied. The output contains data required to substantiate the design of a reinforced concrete or clay masonry element in a format that is suitable for submittal to a building department or other authority. *(CMA - CP001 - \$180.00)

Typical Masonry Details AutoCAD/PDF

An electronic collection of 43 masonry details in AutoCAD format, which can be modified by a professional engineer for incorporation into construction documents. The collection includes details of masonry attachment to foundations, concrete floors, steel framing, glulam beams, and plywood Web I joists, as well as standard reinforcing and control joint details. PDF's of the details are also included. *(CMA - CP002 - \$ 40.00)

*Note: Publications can be purchased from CMACN from the web at: www.cmacn.org, or by calling: 916-722-1700. We can also be contacted at: info@cmacn.org. 50% discount applies for purchases of CMACN publications shipped to California and Nevada.



**Concrete Masonry Association
of California and Nevada**
6060 Sunrise Vista Drive, Suite 1990
Citrus Heights, CA 95610
(916) 722-1700
Info@cmacn.org
www.cmacn.org

Presort
Standard
U.S. Postage
PAID
Permit No. 604
Sacramento, CA

CHANGE SERVICE REQUESTED

Concrete Masonry is
Safe & Sound.
www.cmacn.org

Now Available: 2006 Design of Reinforced Masonry Structures, CMD06 Computer Program, Typical Masonry Details CD includes AutoCAD and PDF formats

Concrete Masonry Association of California and Nevada (CMACN) is pleased to introduce updated products for practicing engineers. See inside for additional details.

Orders can be placed on line at www.cmacn.org (all cards accepted) or by calling (916) 722-1700 (Visa and MasterCard only).

CMACN ACTIVE MEMBERS

Active Members are an individual, partnership, or corporation, which is actively engaged in the manufacture and sale of concrete masonry units.

- ◆ Air Vol Block, Inc.
- ◆ Angelus Block Company, Inc.
- ◆ Basalite Concrete Products, LLC
- ◆ Blocklite
- ◆ CEMEX
- ◆ Cind-R-Lite Block Company, Inc.
- ◆ Calstone Company, Inc.
- ◆ Desert Block Company, Inc.
- ◆ Oldcastle APG West, Inc.
- ◆ ORCO Block Company, Inc.
- ◆ RCP Block & Brick, Inc.